

TR-75G

RF Transceiver Module

Data Sheet

Description

TR-75G is a family of IQRF transceiver modules operating in the 868 MHz and 916 MHz license free ISM (Industry, Scientific and Medical) frequency band. Its highly integrated ready-to-use design containing MCU, RF circuitry, serial EEPROM and on-board antenna requires no external components. Vertical mounting and very small dimensions allow space saving. Extra low power consumption fits for battery powered applications. Flexible MCU pins enable extended functionality and simpler application circuitry and PCB. Extended MCU memories include built-in operating system which significantly reduces application development time. Optional DPA framework supports applications even without programming.



Key features

- Operating system (upgradeable at the user), easy to use
- DPA framework for mesh network applications
- GFSK modulation
- Selectable RF band 868 / 916 MHz, multiple channel
- RF output power 10 mW (10 dBm) with antenna connector
- Eff. radiated power 1.6 mW (2 dBm) with on-board antenna
- MCU with significantly extended memories for program and data
- Extended MCU resources (interrupt capability and programmable internal pull-ups on all I/O pins, remappable digital peripherals, ...)
- Extra low power consumption, power management modes
- SPI interface supported by OS in background
- Serial EEPROM 256 Kb
- Multiple PWM output
- Extended programmable HW timer options
- Battery monitoring
- 2 LEDs
- 12 pins (9 I/O pins, 1 input only pin)
- A/D converter (multiple channels)
- Analog comparator
- Vertical mounting, compatible with SIM card connector without metallic holder (KON-SIM-02)
- Small dimensions

Applications

- Bidirectional RF communication
- Point-to-point or network wireless connectivity
- Telemetry, AMR (automatic meter reading)
- WSN (wireless sensor network)
- Building automation
- Street lighting control
- Wireless monitoring, control and regulation
- Remote data acquisition
- RF connectivity in many other fields
- Also for municipal and indoor areas
- Internet of Things

Block diagram

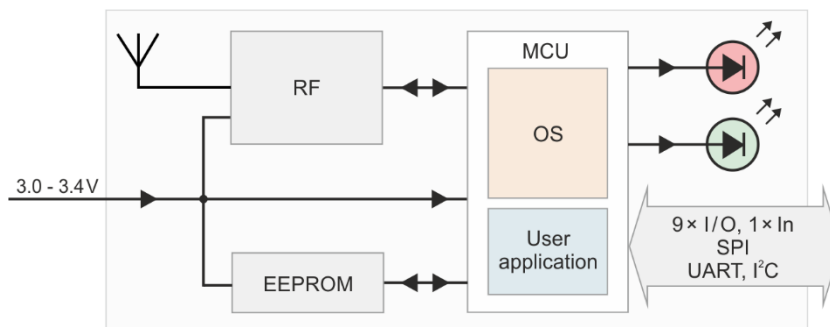

The information contained in this publication regarding device applications and the like is provided only for your convenience and may be superseded by updates. It is your responsibility to ensure that your application meets your specifications.

IQRF Tech MAKES NO REPRESENTATIONS OR WARRANTIES OF ANY KIND TO STATED CONDITION, QUALITY, PERFORMANCE, MERCHANTABILITY OR FITNESS FOR PURPOSE and disclaims all liability arising from this information and its use. Use of IQRF Tech devices in life support and/or safety applications is entirely at the buyer's risk, and the buyer agrees to defend, indemnify and hold harmless IQRF Tech from any and all damages, claims, suits, or expenses resulting from such use. No licenses are conveyed, implicitly or otherwise, under any IQRF Tech intellectual property rights.

Technical specifications

Typical values unless otherwise stated

Parameters specified in this datasheet are typical values. They are at power supply $V_{CC} = 3\text{ V}$ only. V_{CC} voltage different from 3 V can impact on RF range and other parameters.

Supply voltage (V_{CC}) ¹	3.0 V min., 3.4 V max., stabilized
Operating temperature ²	-40 °C to +85 °C
Supply current	
Deep sleep mode	< 300 nA (all peripherals disabled ⁴ , RF IC in Standby mode)
Sleep mode	< 1 µA (all peripherals disabled ⁴ , RF IC in Sleep mode)
Run mode	
RF sleep	1.8 mA
RF ready	3.3 mA
RX mode	
STD	12.5 mA
LP ⁵	190 µA
XLP ⁵	13 µA
TX mode	8 mA – 25 mA (according to RF output power)
Additional LED supply current	About 2 mA per LED. Rough value for brief guidance only.
RF band	
RF channels	868 MHz or 916 MHz (software configurable) See IQRF OS User's guide, Appendix <i>Channel maps</i>
RF data modulation	GFSK (Gaussian Frequency Shift Keying)
RF data transmission bit rate	19.8 kb/s
RF receiver category	1.5 (according to ETSI EN 300 220-1 V3.1.1)
RF sensitivity	-94 dBm (STD RX mode, <code>checkRF(0)</code>). See Diagram 3 .
Effective radiated power	Up to 2.0 dBm (868 MHz band), 0.0 to 2.0 dBm (916 MHz band). See Table 1 .
Antenna	PCB meander line, linear polarization, omnidirectional. See Diagram 1 .
RF range ³	500 m
Input voltage on I/O pins	0 V to VCC
A/D converter	10 bit, multiple inputs. Refer to MCU datasheet.
Size (L x W x H)	27.5 mm x 14.9 mm x 3.3 mm
Storage environment	Temperature +16 °C to +24 °C, relative humidity 65 % max., chemically indifferent

- Note 1:** RF power and other parameters depend on the supply voltage. Refer to datasheets of MCU and RF IC used. Test your application with respect to required supply voltage range.
- Note 2:** RF range may change with lower temperature. Frost, condensation or humidity over 85% may disable module functionality. Module suitability should be tested in the final application at real conditions before volume use.
- Note 3:** Since the radiated power and the RF sensitivity of the TR-75GA and TR-72GA is the same, under the same installation conditions the TR-75GA has the same RF range as the TR-72GA.
- Note 4:** Additional current is consumed when a peripheral (e.g. watchdog, Brown-out detection etc.) is enabled.
- Note 5:** Depends on interferences.

Absolute maximum ratings

Stresses above listed maximum values may cause permanent damage to the device and affect device reliability. Functional operation under these or any other conditions beyond those specified is not supported.

Supply voltage (V _{CC})	3.9 V
Voltage on I/O pins (configured as inputs) vs. GND	-0.3 V to (V _{CC} + 0.3 V)
Storage temperature	-40 °C to +85 °C
Ambient temperature under bias	-40 °C to +85 °C

Caution: Electrostatic sensitive device. Observe appropriate precautions for handling.

Simplified circuit diagram

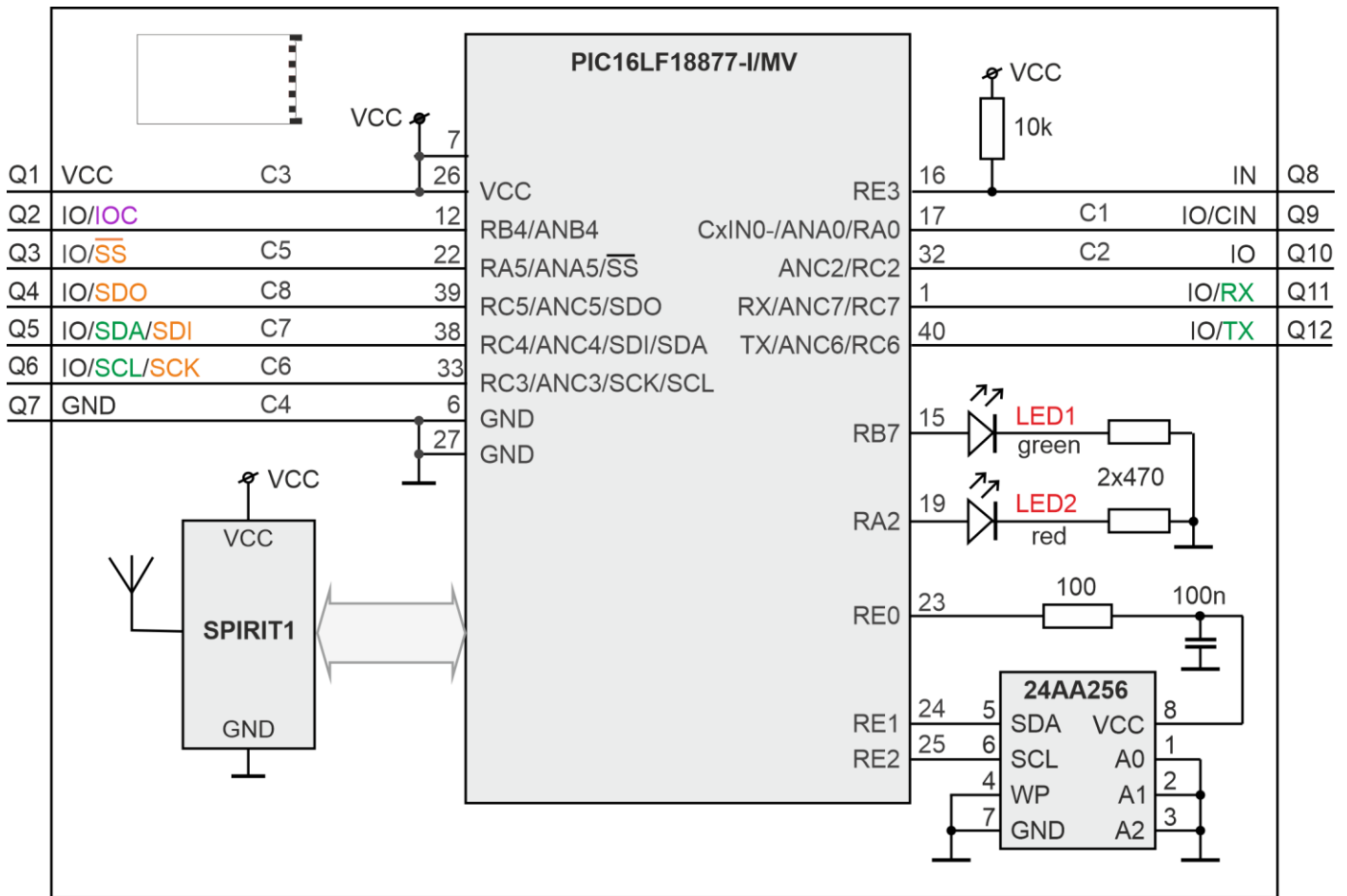

The colors indicate the constraints on the MCU digital peripheral pin remapping using PPS with respect to IQRF OS and DPA. See [Note 2](#) below and the Application note [AN015 - IQRF HW design](#), chapter PPS.

Basic components

IC	Type	Manufacturer	Note
MCU	PIC16LF18877-I/MV	Microchip	
RF IC	SPIRIT1	STMicroelectronics	
RF balun	BALF-SPI-01D3	STMicroelectronics	
EEPROM	24AA256-I/CS16K	Microchip	For HW revision v1.00
	N24C256C6DYT3G	ON Semiconductor	For HW revision v1.10

For more information refer to datasheets of ICs used.

Pin	Name	Description
Q1, C3	V _{CC}	Power supply voltage
Q2	IO RB4	General I/O pin Interrupt/Wake-up on change (IOC) supported by IQRF OS and DPA. RFPGM / (X)LP mode termination. Dedicated for DPA menu (for DPA v4.30 or higher)
	ANB4	Analog A/D input
Q3, C5	IO / -SS RA5 -SS ² ANA5	General I/O pin SPI Slave select Analog A/D input
Q4 ¹ , C8	IO / SDO RC5 SDO ² ANC5	General I/O pin SPI data output Analog A/D input
Q5 ¹ , C7	IO / SDI / SDA RC4 SDI ² SDA ² ANC4	General I/O pin SPI data input I ² C data Analog A/D input
Q6, C6	IO / SCK / SCL RC3 SCK ² SCL ² ANC3	General I/O pin SPI clock input I ² C clock Analog A/D input
Q7, C4	GND	Ground
Q8	IN RE3	General input only pin
Q9, C1	IO / C-IN RA0 ANA0 CxIN0-	General I/O pin Analog A/D input Comparator -input
Q10, C2	IO RC2 ANC2	General I/O pin Analog A/D input
Q11	IO / RX RC7 RX ² ANC7	General I/O pin UART RX Analog A/D input
Q12	IO / TX / PWM RC6 TX ² ANC6	General I/O pin UART TX Analog A/D input
P1–P5	For manufacturer only	

Top view



Bottom view

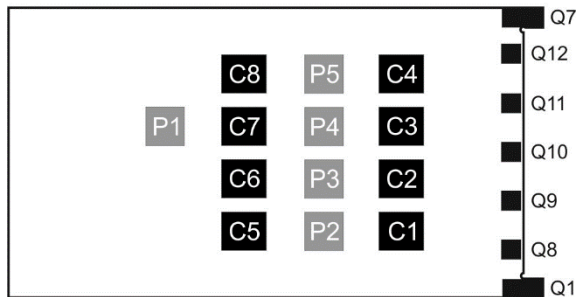

All MCU pins connected to TR I/O pins (Q2 to Q12) are equipped with the interrupt on change capability (except Q8), programmable pull-up resistor, and (except Q8) can be used as analog inputs for A/D converter.

Note 1: Pin Q4 is used as output and pin Q5 as input during the initial approximately 200 ms boot-up (after TR reset) to detect a possible request to enter the programming mode (PGM - wired upload via SPI). After reset, the OS generates a determinate sequence on the Q4 pin. If this sequence is copied to the Q5, the OS jumps to the PGM bootloader. (The PGM mode is indicated by short red LED flashing every 2 s.)

This must be taken into account to avoid collisions with application circuitry connected to these pins.

The Q5 pin must not be interconnected to Q4 or left unconnected or without a **defined level** on its input. This level must be arranged **by application hardware**. If the application circuitry ensures no such level, a **pull-down resistor on Q5 pin** must be used otherwise a **cross-talk** between Q4 and Q5 may cause an unintentional switching to PGM.

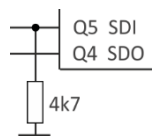

Note 2: All MCU pins dedicated to digital signals of internal peripherals (e.g. UART, I²C, SPI, PWM, timers, analog comparator output, etc.) are remappable in SW. See the MCU datasheet, chapter *Peripheral Pin Select (PPS)* and the application note [AN015 - IQRF HW design](#), chapter *PPS*. The list above denotes only the pins assigned to UART, I²C, and SPI by default. Other remappable peripherals (e.g. PWM or analog comparator output) are not denoted there.

There are no on-board protection series resistors on I/O pins. It is recommended to use 200 Ω series resistors on each pin. See the application note [AN015 - IQRF HW design](#).

Recommended circuit for development

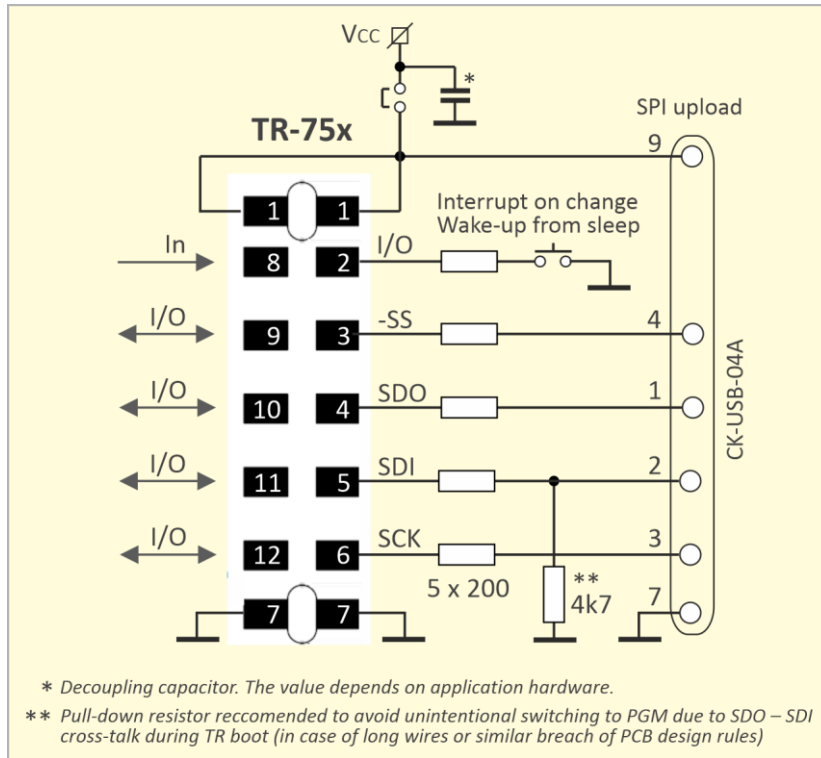

For development, it is recommended to implement the following arrangement:

- Decoupling capacitor on V_{CC} to filter the supply voltage. The type and the value should be selected with respect to general rules observed in electronic design, according to given application hardware and power source.
- Serial protective resistors on each I/O pin used.
- Pin Q2 configured as an input with the internal pull-up resistor and equipped with a pushbutton connected to the ground. Then pressing the button can generate an interrupt on pin change, wake-up the transceiver from sleep, terminate RFPGM mode, initiate bonding etc.
- Pull-down resistor on pin Q5 recommended to avoid unintentional switching to PGM mode due to SDO - SDI cross-talk during TR boot.
- SPI interface for wired upload of application code into the transceiver using an IQRF programmer, e.g CK-USB-04A.

Depending on actual user application and power supply range, it may be required to isolate interface pins and/or power supply from user circuitry during uploading. For details refer to the CK-USB-04A User's guide, chapter *Application/In-circuit upload*.

RF range

Refer to the Application note [AN014 – RF range](#). RF range strongly depends on the following design aspects:

- Hardware:
 - Construction of the devices (especially TR location within the device, PCB layout, ground planes, conductive areas and bulk objects such as metallic parts and batteries in the nearest surroundings, with respect to possible reflections and counterpoise effect). To achieve an efficient range and reliable connectivity, no parts impacting the range must be placed close to the built-in meander antenna. Even non-conductive parts can significantly impact the range.
 - Physical arrangement of devices (especially mutual orientations of antennas with respect to polarizations and radiation patterns)
- Application software:
 - RF output power is selectable from 8 levels
 - To increase immunity to RF noise, incoming RF signals can be filtered according to signal strength. See the *IQRF OS Reference guide*, function `checkRF` and configuration parameter *RX filter*.

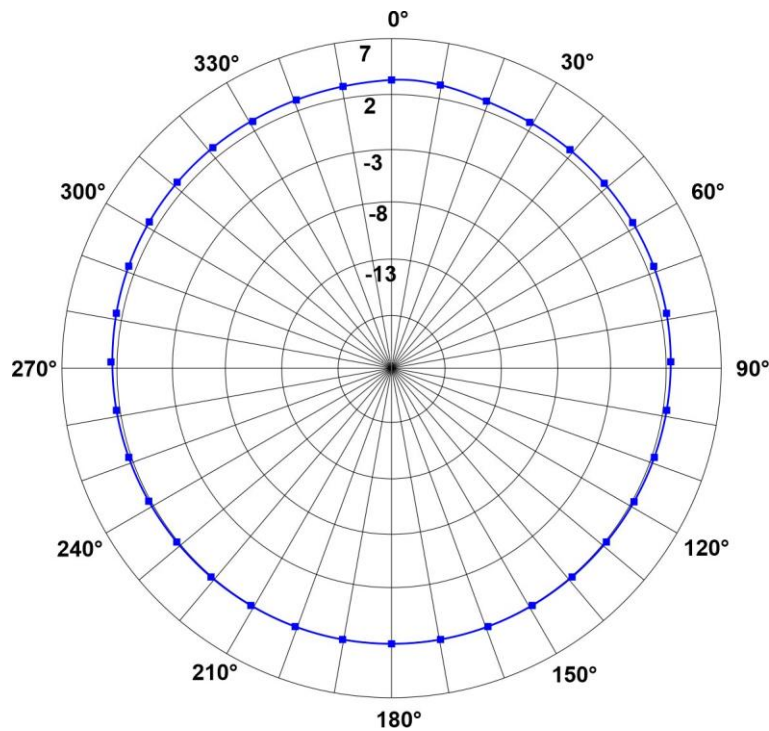
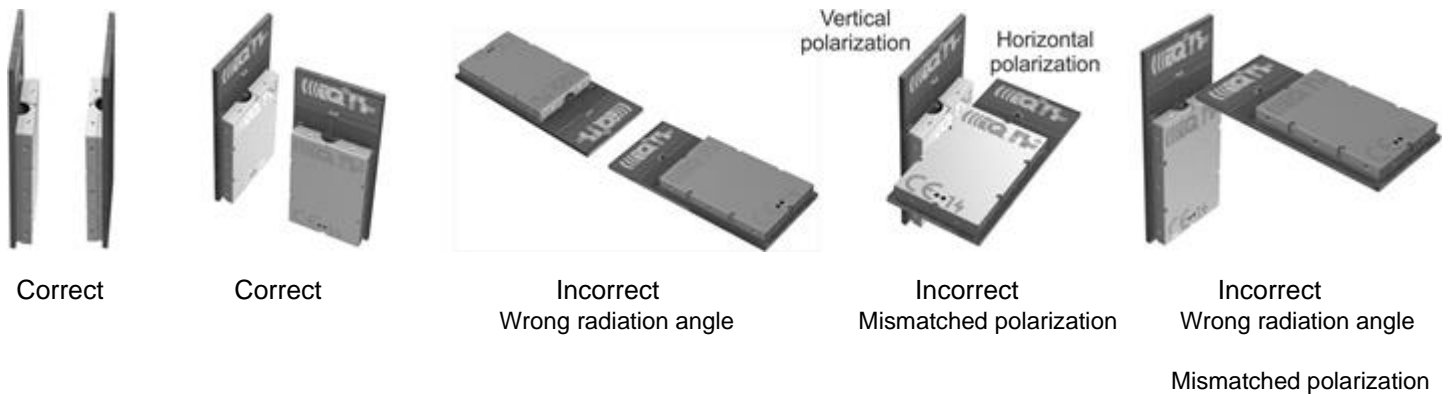

Diagram 1: TR-75GA RF output power [in dBm] vs. antenna orientation (radiation patterns) in horizontal plane, when the antenna is oriented vertically.

Examples of the correct and incorrect arrangement of TR-7xDA pairs:



The **Effective radiated power** (ERP) in the 868 MHz band is constant for all channels. The ERP in the 916 MHz band decreases to higher channels. The ERP drop on channel 255 relative to the power on channel 0 is 2 dBm.

level	ERP [dBm]			
	868 MHz	916 MHz		
	Channels 0 to 67	Channel 0	Channel 104	Channel 255
7	2	2	1	0
6	-1	-1	-2	-3
5	-6	-6	-7	-8
4	-10	-10	-11	-12
3	-16	-16	-17	-18
2	-22	-22	-23	-24
1	-34	-34	-35	-36
0	-42	-42	-43	-44

Table 1: TR-75GA effective radiated power (ERP) vs. level in the `setRFpower(level)` function.

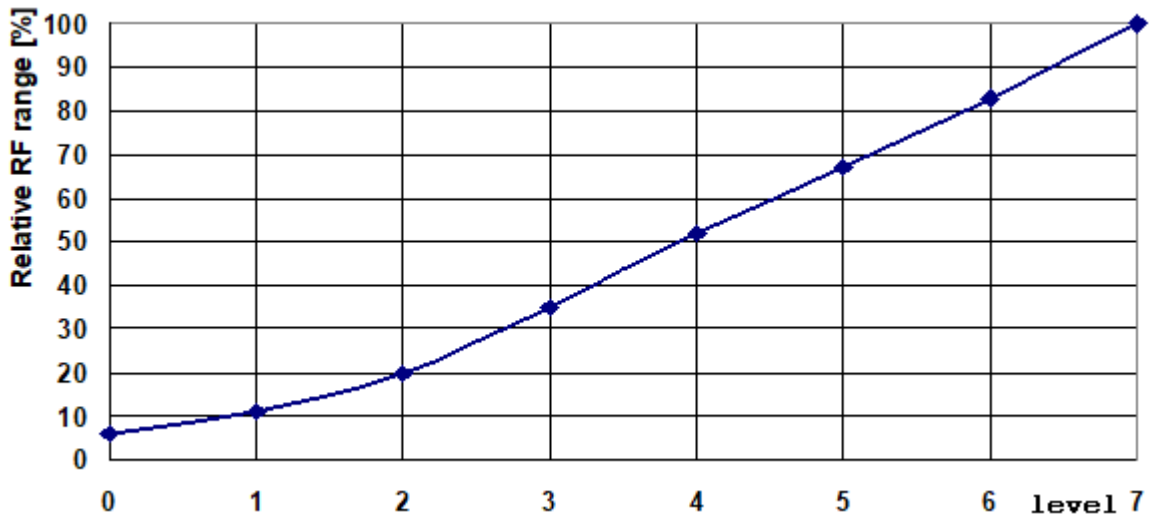

Diagram 2: TR-75GA relative RF range vs. level in the `setRFpower(level)` function.

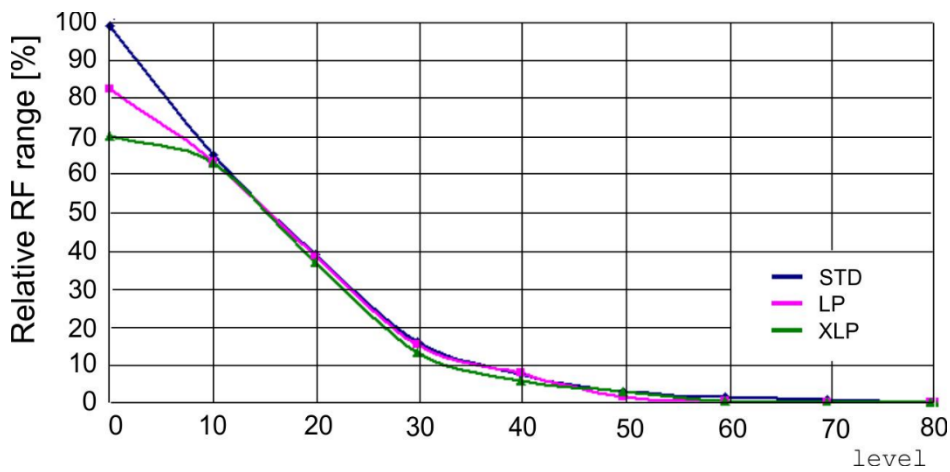

Diagram 3: Relative RF range vs. level in the `checkRF(level)` function in STD, LP, and XLP RX modes.

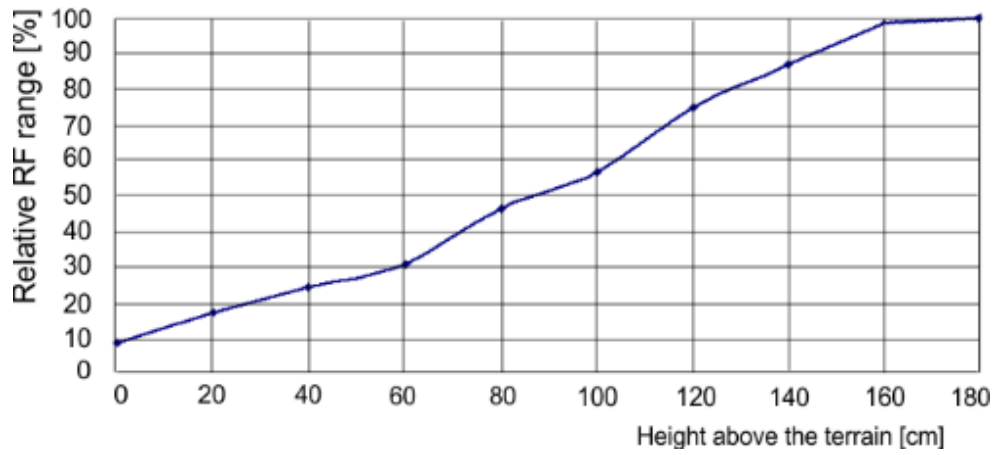
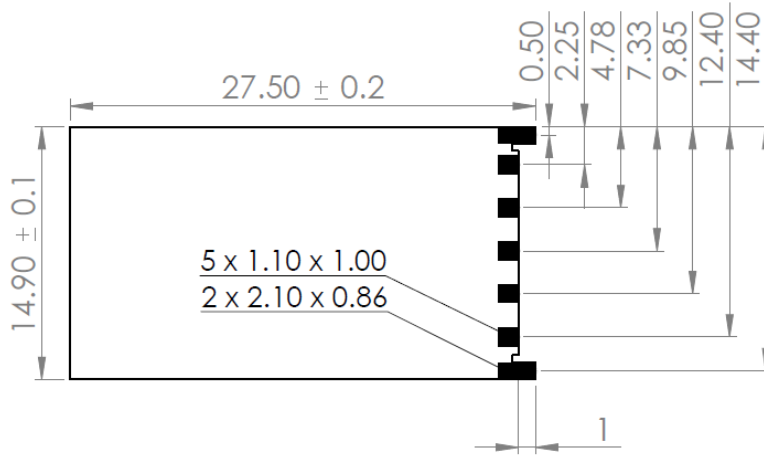

Diagram 4: TR-75GA relative RF range vs. antenna height above the ground, 868 MHz and 916 MHz bands.

Mechanical drawings

Top



Bottom

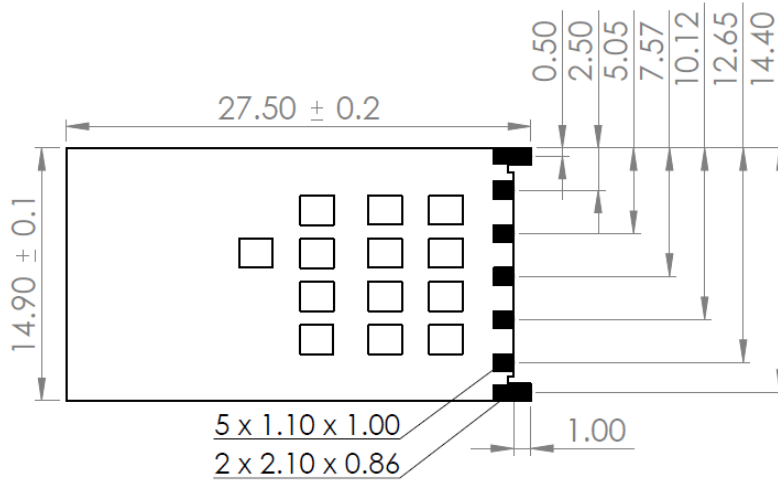

Units: mm.

Hardware revision

- TR-75GA v1.00 First release.

Application

Users have to ensure observing local provisions and restrictions relating to the use of short-range devices **by software**, e.g. the CEPT ERC/REC 70-03 Recommendation and subsequent amendments in EU.

See the Application notes [AN015 - IQRF HW design](#) and [AN014 – RF range](#), and [IQRF video tutorial set](#).

Recommended PCB layout

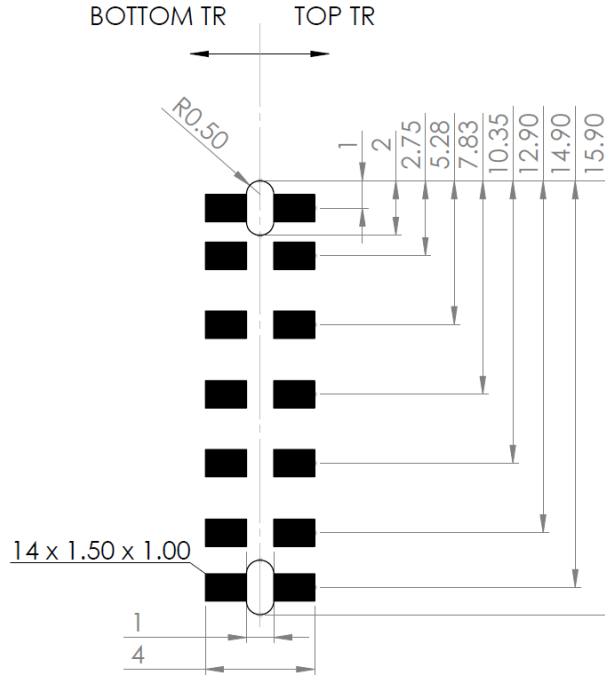

This pattern is for reference purposes only. Consult your producer to ensure that its manufacturing guidelines are met.

Sealing

In case of sealing or protecting TR modules against a harsh environment by coating, encapsulating, or potting using a lacquer, gel, or other filling matter, refer to the *Application note AN015 - IQRF HW design*, chapter *Sealing*.

Operating system

See IQRF OS User's guide and IQRF OS Reference guide.

DPA framework

See DPA Framework technical guide.

Application software

See IQRF Quick start guide and IQRF application examples.

Programming (upload)

There are the following possibilities to upload an application program in TR-75Gx transceivers:

- Wired upload with TR-75Gx plugged via the SIM connector in the CK-USB-04A programmer.
- For TR-75Gx modules populated in an application:
 - Wired upload
 - Using the CK-USB-04A programmer. See the CK-USB-04A User's guide.
 - Using the CK-USB-04 programmer and the KON-TR-01P adapter. See the KON-TR-01P User's guide.
 - Completely arranged by user application. See the *IQRF SPI Technical guide*, chapter *Programming mode*.
 - Wireless upload: See the IQRF OS User's guide, Appendix *RFPGM – RF programming™*.

Product information

Ordering codes

TR-75G A

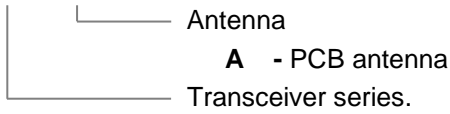

Type	Antenna connection
TR-75GA	PCB antenna

Document history

- 240410 The pin description is revised with respect to PPS. *Simplified circuit diagram* is slightly improved. Directives in chapter *Quality management* update. Some minor improvements. Document non-preliminary.
- 230519 The description of pins on page 5 is slightly extended.
- 230220 Delivered without a shielding can.
- 221118 Bug in *Table 1* fixed.
- 221004 Bug in MCU type designation in chapters *Simplified circuit diagram* and *Key components* fixed.
- 220718 Preliminary release.

Sales and Service

Corporate office

IQRF Tech s.r.o., Prumyslova 1275, 506 01 Jicin, Czech Republic, EU
Tel: +420 493 538 125, Fax: +420 493 538 126, www.iqrf.tech
E-mail (commercial matters): sales@iqrf.org

Technology and development

www.iqrf.org
E-mail (technical matters): support@iqrf.org

Partners and distribution

Distributors: www.iqrf.org/partners
IQRF E-shop: <https://eshop.iqrf.org>

Quality management

ISO 9001 : 2016 certified.

When used under the conditions of use specified by the manufacturer, the product complies with the essential requirements and other relevant provisions of the directives 2004/108/EC (EMC), 2014/53/EU (RED), and 2018/738/EU (RoHS).



Harmonized standards or other relevant technical specifications used on the basis of which conformity is declared:

Radio spectrum:	ETSI EN 301 489-3 V2.1.1
EMC:	ETSI EN 301 489-1 V2.2.3
	EN 55032 ed. 2
	EN 55035
Safety:	EN IEC 62368-1 ed. 2+A11
RoHS:	EN IEC 63000

Trademarks

The IQRF name and logo are registered trademarks of IQRF Tech s.r.o.
All other trademarks mentioned herein are property of their respective owners.

Legal

All information contained in this publication is intended through suggestion only and may be superseded by updates without prior notice. No representation or warranty is given and no liability is assumed by IQRF Tech s.r.o. with respect to the accuracy or use of such information.

Without written permission, it is not allowed to copy or reproduce this information, even partially.

No licenses are conveyed, implicitly or otherwise, under any intellectual property rights.

The IQRF® products utilize several patents (CZ, EU, US).

Online support: support@iqrf.org
